

# LASER TECHNOLOGY

Groundbreaking in the  
laser processing of cutting tools

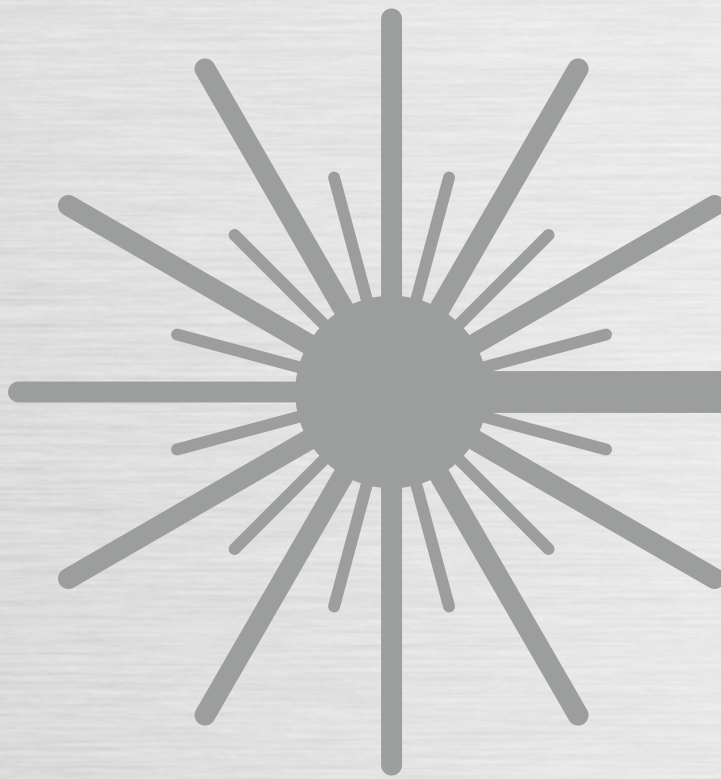

## Key parameters

The machining of modern materials using laser technology knows no limits. Simple to use software designed for universal applications for the efficient production of even the most sophisticated tool geometries. Discover the possibilities and the right system configuration to fit your needs.



Grinding



Eroding



Laser



Measuring



Software



Customer Care

## EWAG

---

The origins of EWAG date back to 1946 when the company manufactured precision tool grinding machines for the Swiss watch industry. Today the EWAG product range includes a CNC tool grinding machine for grinding inserts as well as laser machines for indexable cutting inserts and rotationally symmetrical tools made from hard and ultrahard materials such as carbide CBN or PCD.

EWAG belongs to the UNITED GRINDING Group. Together with our sister company, Walter Maschinenbau GmbH, we consider ourselves to be a supplier of systems and solutions for the complete machining of tools and can offer a wide range of products, including grinding, rotary eroding, laser machining, measurement and software.

Our customer focus and our global sales and service network of company owned locations and employees has been appreciated by our customers for decades.

# LASER TECHNOLOGY

As a pioneer of the 5-axis complete laser machining of diamond blades and 3D cavities using ultrashort pulse lasers and integrated scanner technology, EWAG has been continuously developing and leaving their mark on laser technology since 2009. EWAG is steadily expanding their product and application portfolio with new methods, such as EWAG Laser Touch Machining<sup>®</sup>, as well as new laser sources and systems.



Laser

# The way to 3D laser ablation

1

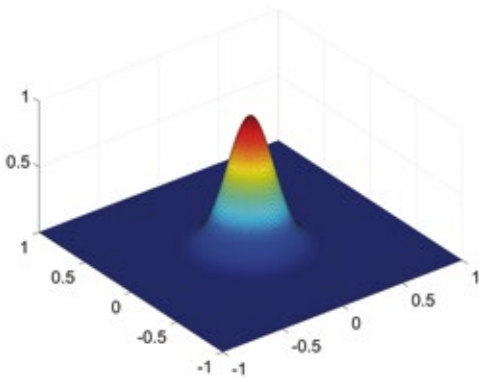
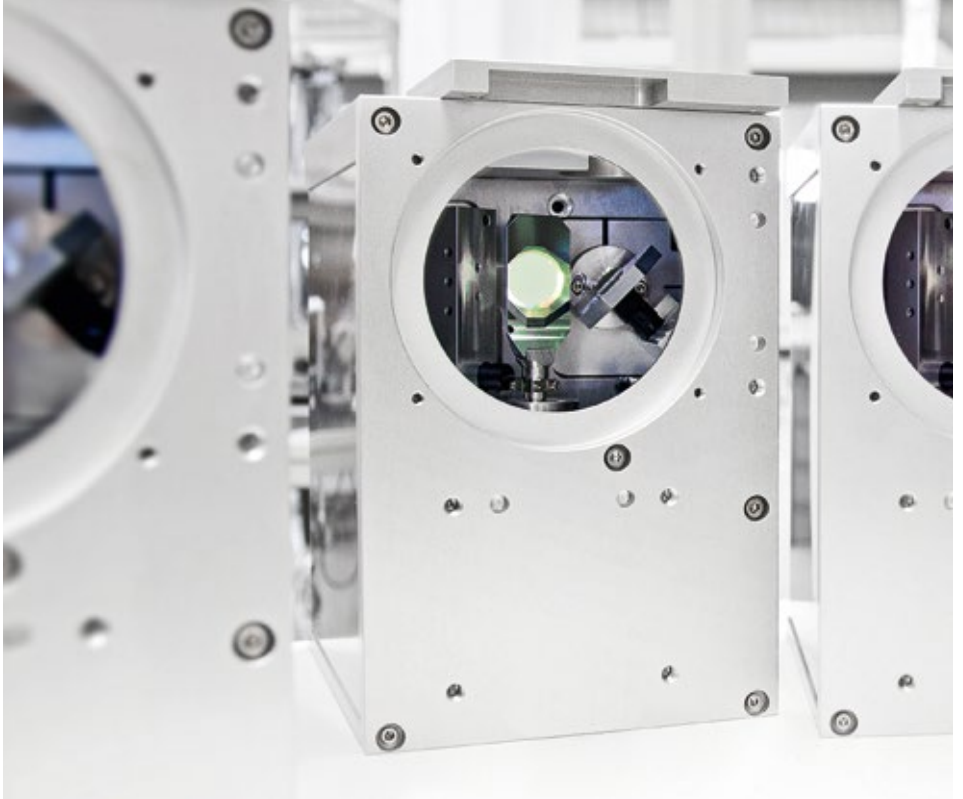

- Gaussian beam profile
- Fast beam deflection
- Flexibility in 3D

Pulsed laser systems deliver individual pulses with a Gaussian intensity distribution. Pulse quality, pulse duration as well as pulse frequency vary, depending on the laser system used, and deliver different ablation results. The individual pulse shot generates a corresponding crater. In order to make it possible to machine geometries, the individual pulses are strung together, overlapping, to create a line. If several lines are arranged so they overlap in parallel, a two-dimensional laser ablation is created. If several of these areas are now overlapped and the individual ablation planes are shifted by a defined amount, an ablation pocket is ultimately created.

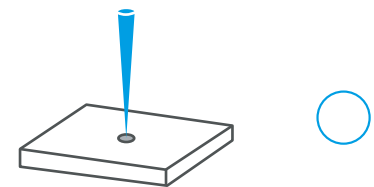

Single pulse shot

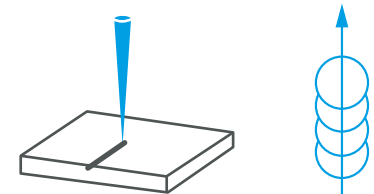

Line made up of overlapping pulses

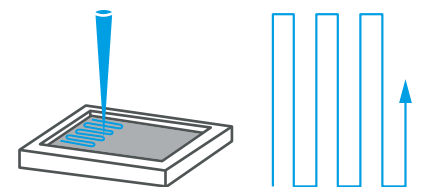

3D volume ablation

### The system setup

The beam guidance designs vary depending on the laser system used. Nanosecond pulse trains from pulsed fiber lasers (ns lasers) can be guided in optical fibers and simplify the system setup. Ultrashort pulse lasers (ps lasers), which generate laser pulses in the picosecond range, cannot be guided in an optical fiber. The beam guidance using deflection mirrors is correspondingly more complicated for ultrashort pulse laser systems. Depending on the nature of the raw beam of the used laser system, beam expansion might be necessary in order to ensure that the laser beam can be cleanly focused. Due to the very high pulse frequencies of the laser systems, the individual pulses must be separated very quickly. To do this, galvanometer scanning heads are preferred today, which can deflect the laser beam on a 2D plane using two very fast and precise galvo-mirror units in order to achieve the described 3D ablation. The deflected laser beam is focused in a downstream plane-field lens (F-theta lens), which largely defines the machining distance as well as the focal point size. In order to efficiently attain 3D volume ablation, an optional beam telescope upstream of the scanner head is used. The beam telescope has a motor-driven lens, which can automatically and quickly shift the focal plane in a certain range. The layer infeed for 3D ablation can be done automatically without having to move the machine axes in the process.

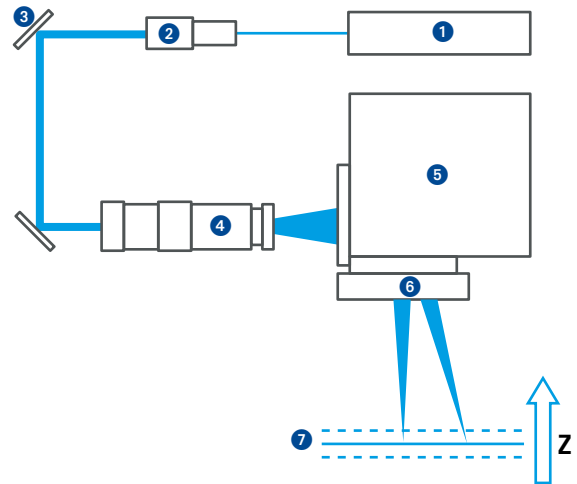

Beam guidance using deflection mirrors in ultrashort pulse laser systems

- |                       |                          |
|-----------------------|--------------------------|
| ① Laser system        | ⑤ Galvanometer scan head |
| ② Beam expander       | ⑥ F-theta lens           |
| ③ Deflection mirror   | ⑦ Workpiece plane        |
| ④ Focus shifting unit |                          |

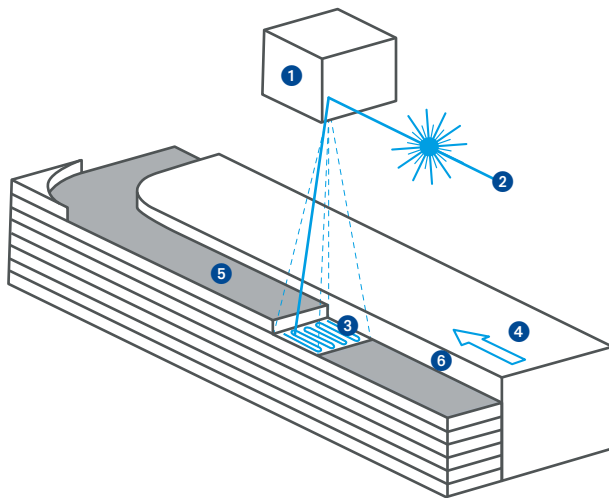

EWAG Laser Touch Machining®

- |   |                               |
|---|-------------------------------|
| ① Galvanometer scan head                        | ⑤ Machined erosion paths      |
| ② Laser beam                                    | ⑥ Final geometry/free surface |
| ③ Repeating 2D pattern                          |                               |
| ④ Workpiece movement via 5-axis CNC (X/Y/Z/B/C) |                               |

### Generation of a cutting edge with EWAG Laser Touch Machining®

EWAG focuses on tangential laser beam processing for the efficient, high-quality generation of cutting edges and blade geometries. Hereby, the free surface quality is established with the lateral surface of the laser beams. In order to generate a corresponding kerf, a repetitive hatch pattern is generated with the scan head with a simultaneous traversing movement of the CNC axes. The material-dependent ablation settings can be ideally controlled with the hatch shape, hatch pattern, scan speed and pulse frequency, independent of the traversing speed of the CNC axes. For high profile precision of the cutting edge, the CNC axes can be traversed correspondingly slowly, and the laser pulses are separated, even for the maximum pulse frequencies, by controlling the hatching here. The free surface and its clearance angle curve are formed via the infeed depth and lead angle of the blade geometry. This unique, patented machining technology is marketed under the brand EWAG Laser Touch Machining® (LTM®).

# Influence of the pulse duration on the machining result

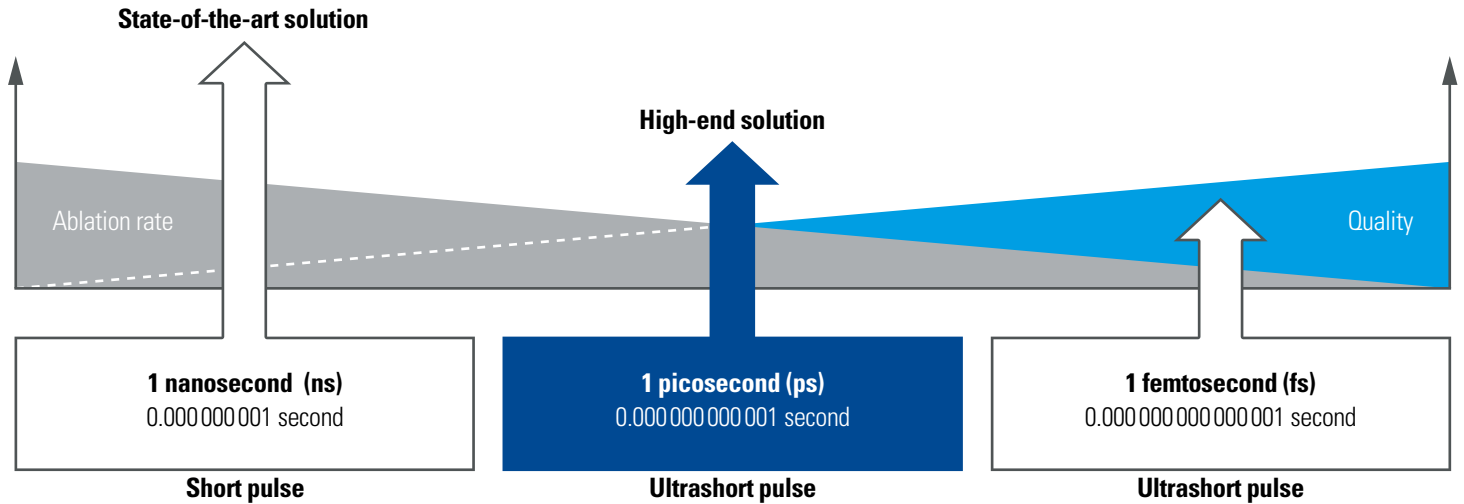

- Short laser pulses (ns) for high ablation
- Ultrashort laser pulses (ps/fs) for maximum quality
- Efficiency & quality at 10 ps

The peak intensity of the individual pulse increases dramatically with decreasing laser pulse duration due to the strong time compression with an unchanging average laser power. Laser beam sources which emit pulsed laser light with pulse durations in the picoseconds or femtosecond range are referred to as ultrashort pulse lasers. These kinds of ultrashort pulse lasers have the unique property that the energy is transmitted from the photons to the electrons so quickly, that the material sublimates (converts directly from a solid to a gas) before heat can be transferred to the material surroundings. This makes highly precise material removal possible, such that temperature-sensitive materials can be machined without thermal damage. However, as the pulse durations become shorter and shorter, the available energy that the laser pulse can transport goes down. This leads to a reduced amount of material removal per pulse,

and therefore to a generally lower ablation rate. To counteract this effect, ultrashort pulse lasers have a much higher pulse frequency (in the MHz range) than conventional short pulse lasers (in the kHz range). Short pulse lasers, however, often have a higher average power and can therefore achieve relatively high removal rates. Due to their pulse duration in the nanosecond range, however, thermal material removal takes place and, in addition to a sublimation component, heat is also transferred to the machined material. Especially in the case of hard and brittle materials, the thermal effect could cause undesirable crack formations and structural changes. Choosing the right laser source, then, strongly depends on the desired machining quality and material being machined.

# Laser pulse material interaction

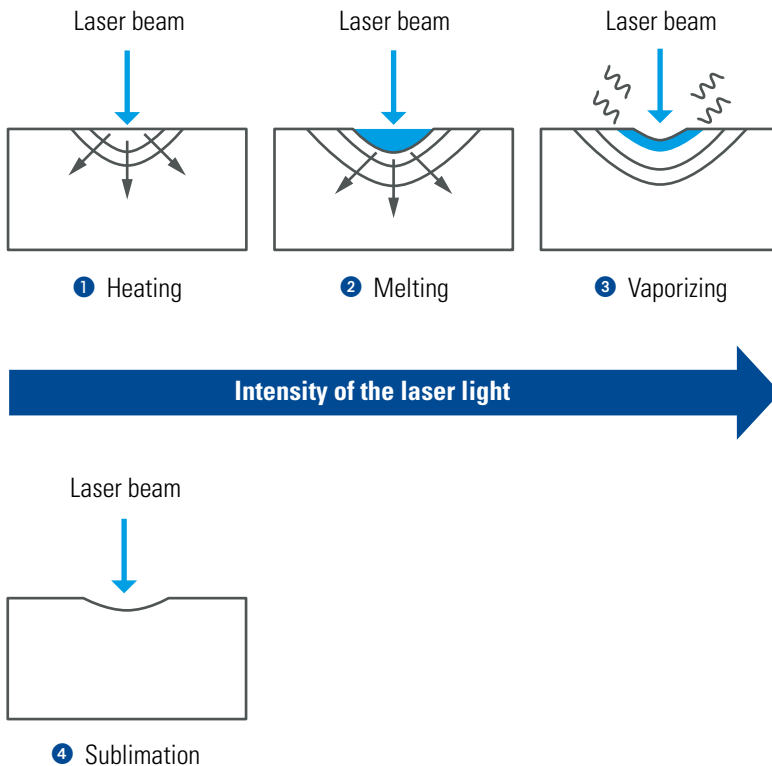

In order to be able to remove material using laser light, energy must be deposited into the workpiece. The type and method of energy input depends on the applied intensity and the pulse duration of the light.

### Image 1-3

In cases of pulse durations greater than 10 picoseconds in length, the material is first heated with increasing intensity, then melted and finally vaporised.

### Image 4

In cases of pulse durations less than 10 picoseconds in length (ultra-short laser pulses), the removal mechanism changes and the material can be transformed from the solid to the gaseous state without melting; this is referred to as sublimation.

### Effects of the degree of absorption on the removal behaviour

Short wavelengths in the green, visible range (532 nm) lead to a higher absorption behaviour for common diamond-cutting materials, and therefore, at constant laser power, to increased material removal as compared to conventional laser systems in the infrared wavelength range (typical for industry: 1064 nm). This absorption behaviour, however, does not apply to ultra-short pulse systems. For these laser pulses, the removal mechanism physically changes, which results in materials otherwise transparent to laser light to be able to be machined.

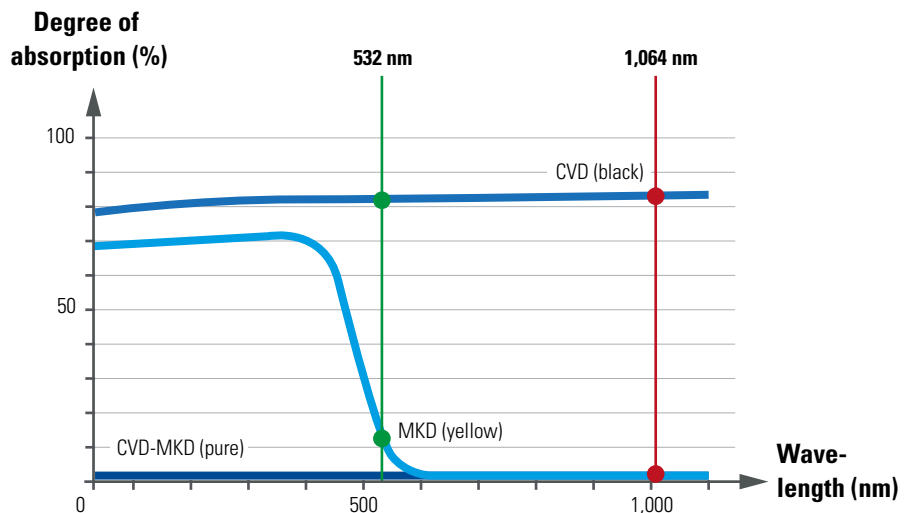

Absorption behaviour of superhard cutting materials.  
© Fraunhofer IPT, Aachen.

# Laser technology comparison



## LASER LINE PRECISION

Rating

Standard

Laser technology

ns laser technology

Properties

- Mainly suitable for diamond materials
- Thermal material removal
- Compact system, small space requirement
- Low-maintenance beam path (fiber)
- Lower investment costs

## LASER LINE ULTRA

Standard / High Power

ps laser technology

- Greatest application versatility
- No thermal material damage
- Gentle material removal
- Optimally suited for all cutting materials, especially hard and brittle materials
- Can be applied to transparent materials without any problems
- Optimally suited for carbides
- Top surface qualities achievable
- Finest image qualities achievable

Wave length

532 nm

Properties

- Increased degree of absorption in diamond cutting materials, double the material removal at the same laser power
- Half the focal diameter at same focal length
- Visible laser radiation (green)

1,064 nm

- Increased degree of absorption in carbides
- Invisible laser radiation (IR)



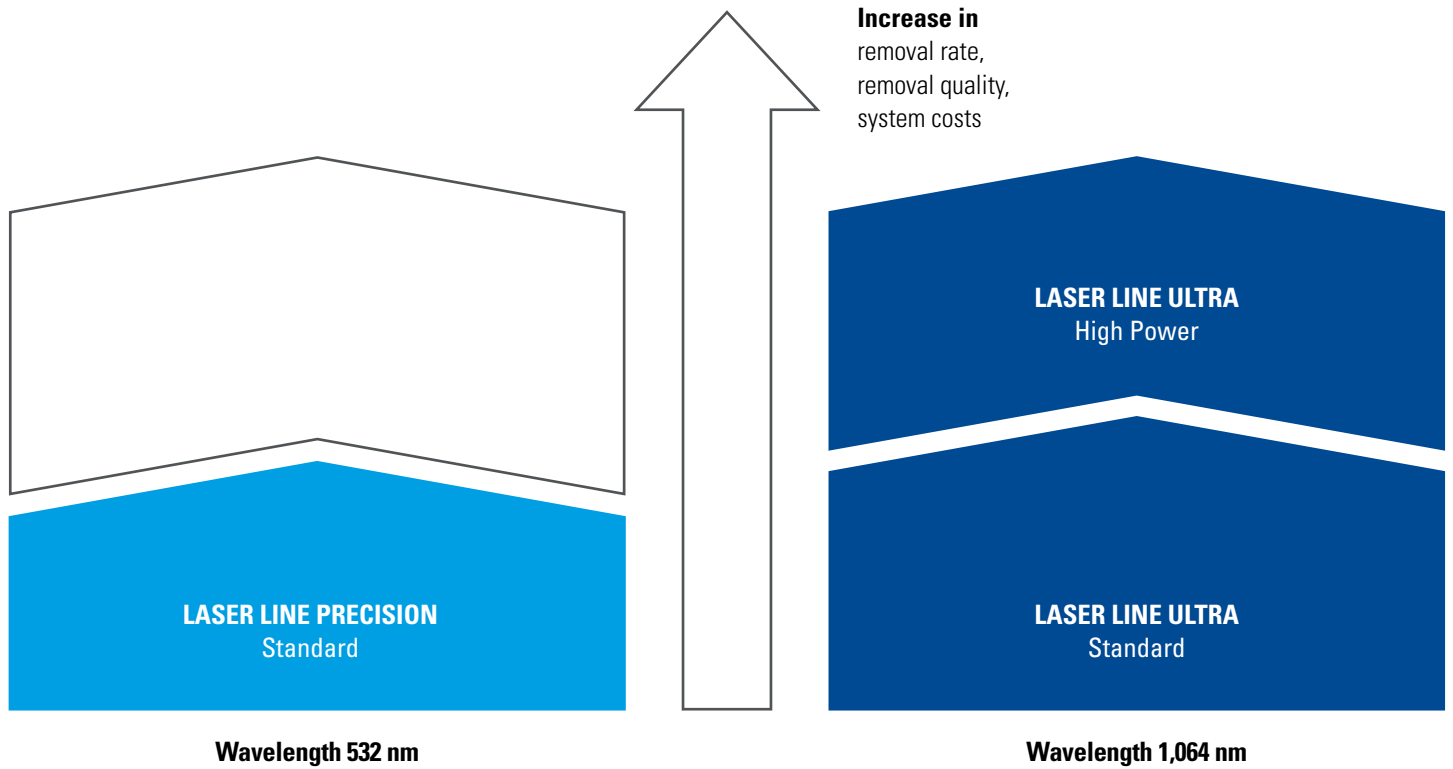

	LASER LINE PRECISION	LASER LINE ULTRA	LASER LINE ULTRA
Power / wavelength	Standard / 532 nm	Standard / 1,064 nm	High Power / 1,064 nm
Application / use	<ul style="list-style-type: none"> <li>– Creation of chip breakers in diamond tools</li> <li>– Creation of tool blades with thin substrates (CVD-D/PCD &lt; 1.6 mm/PCD without carbide)</li> </ul>	<ul style="list-style-type: none"> <li>– Greatest tool application versatility in all cutting materials</li> <li>– Laser refinement of carbide tools</li> <li>– Prototyping of carbide indexable inserts</li> </ul>	<ul style="list-style-type: none"> <li>– Maximum removal rates for all materials</li> <li>– Applications with high carbide volume removal</li> <li>– Long, thick PCD blades (&gt; 1.6 mm PCD)</li> </ul>
Advantage	The economical production machine for diamond tools	The flexible all-rounder for top quality demands for all materials	The powerhouse for extreme material removal
<b>Materials</b>			
Carbide	○		●
Cermet	○		●
Ceramic	○		●
CBN	◐		●
PCD	●		●
CVD-D	●		●
MCD	●		●

○ Of limited suitability ◐ Suitable ● Recommended







Fritz Studer Ltd., EWAG Branch  
Industriestrasse 6 · 4554 Etziken, Switzerland  
Tel. +41 32 613 3131  
Fax +41 32 613 3115  
info@ewag.com

For worldwide contact details, please visit  
**[www.ewag.com](http://www.ewag.com)**

