

MFP 100

Fully automatic complete machining of
complex workpieces

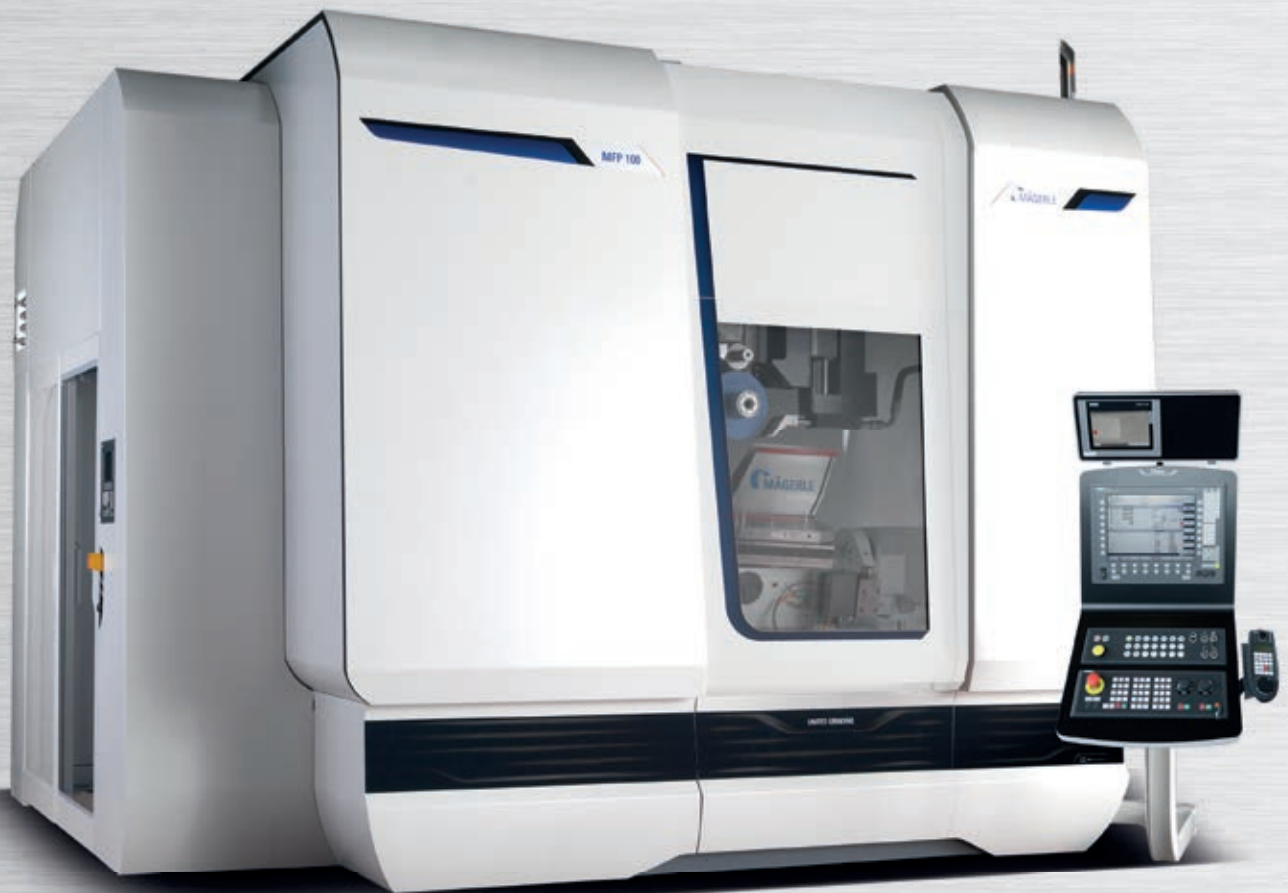

Key data

- Wide variety of tools and process flexibility
- Highest performance and precision
- Swiss-made precision
- Compact layout

Mägerle AG Maschinenfabrik

Precision, quality and flexibility are key attributes of the products manufactured by Mägerle AG Maschinenfabrik. A technology leader for high-performance surface and profile grinding systems, the company founded in 1929 primarily specializes in customized solutions.

At the heart of the international success of our high-quality Swiss machinery is the unique design principle of the MÄGERLE modular system. Thanks to state-of-the-art technology, MÄGERLE can offer customers from many branches of industry reliable grinding centers. The high machining precision of the custom special-purpose machines ensures that our customers remain competitive.

Alongside decades of accumulated expertise, our highly motivated and dedicated employees play a key role in the success of the company.

As part of the UNITED GRINDING Group, MÄGERLE is a strong member of the group of globally leading machinery engineering companies for grinding machines. All over the world, this gives MÄGERLE customers access to an extensive network of experienced service and engineering technicians.

MFP 100

Unique dual gripper changes grinding wheels and dressing rolls simultaneously · Extremely fast axes · Hydrostatic guideways · Maximum grinding and cooling performance · Unique coolant nozzle changer · Process expertise for high process reliability · System integration expertise · Internal tool cooling

Characteristics

Dimensions

- Width: 4.6 m
- Depth: 4 m
- X-axis - longitudinal stroke: 1,000 mm
- Y-axis - vertical stroke: 900 mm
- Z-axis - transverse stroke: 750 mm
- Spindle power up to 50 kW

Hardware

- Precise multi-face machining
- 5 or 6-axis system
- Tool changer with up to 60 tool holders
- Grinding, milling and drilling in a single clamping
- Wear-free hydrostatic guideways
- Water-cooled direct drive
- Diverse chucking
- Short tool change cycles
- Automatic grinding wheel and dressing roll changer
- Through-spindle coolant
- Automatic nozzle changer



Software

- User-specific programmable interface
- Innovative control architecture
- Intuitive operation
- Focus on work and production safety

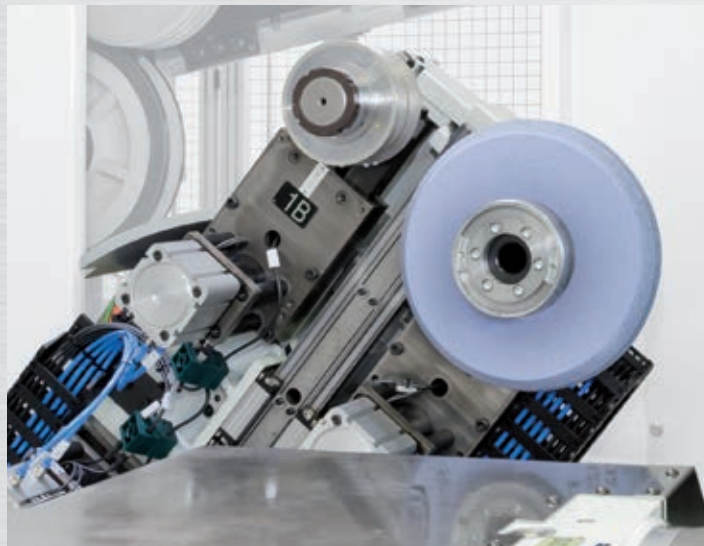
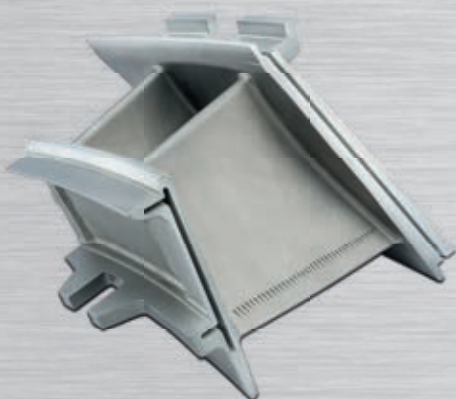
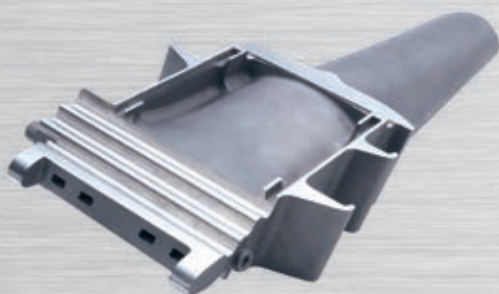

With the MFP 100, Mägerle AG Maschinenfabrik has expanded the MFP series with a particularly flexible grinding center. The new grinding center is characterized by its high working speed and the quick tool change. MÄGERLE has specially designed the MFP 100 for those markets where multi-face machining of heavy and complex workpieces in just a single clamping operation is demanded. With 50 kW spindle power and a generously designed working area, the new MÄGERLE grinding center is ideally suited for processing turbine guide and rotor blades as well as heat shields for use in the aviation and energy industry. The MÄGERLE MFP 100 is supplied with a two-axis NC combination as standard. The grinding center can also be optionally upgraded to a three-axis system. The tool and dressing roll changer system is an outstanding feature of the MFP 100. The dual gripper changes grinding wheels and associated diamond rolls simultaneously - thus resulting in a noticeable reduction in idle time. With its diverse machining capabilities, too, the MFP 100 presents a whole new angle. The standard version of the tool changer can be equipped with up to 30 tool holders. It can optionally be increased to up to 60 tool stations. It is possible to load the tool changer with tools such as drills, milling cutters, CBN wheels or measuring sensors. In spite of its performance characteristics, the MFP 100's compact design is sure to impress. With a width of 4.6 m width and a depth of 4 m, the footprint for a grinding machine of this category is incredibly small. The NC table can be conveniently loaded from above or from the front, manually, with a crane or with a robot. The simple access opening on the rear for scheduled and preventive maintenance supports the outstanding ergonomic design of the new MÄGERLE Grinding Center.

Hydrostatic Guideways

Wear-free guideway concepts

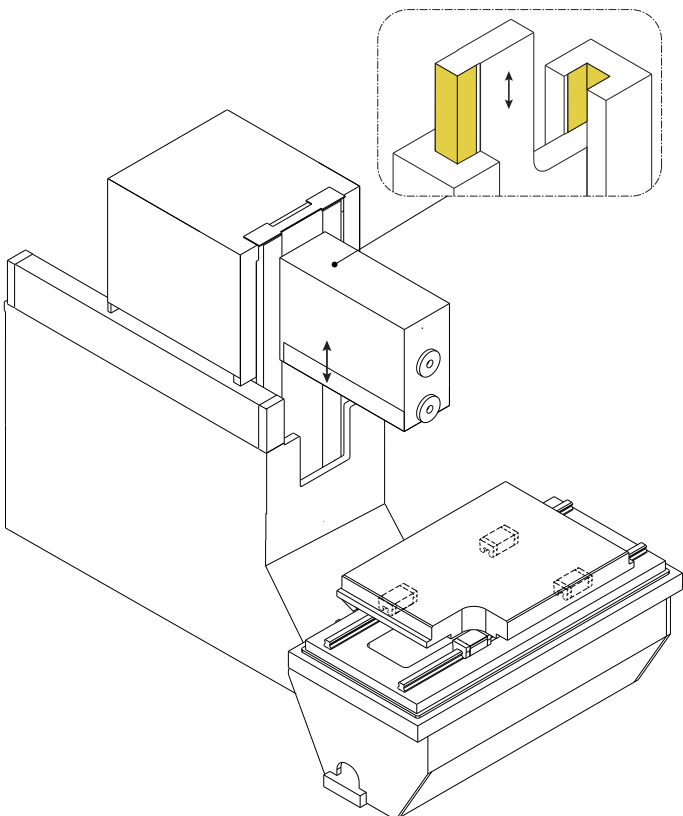

The whole quality of the MÄGERLE Grinding Centers is based on the unique design principle. The axis structure is supported by hydrostatic wrap-around guideways on a thin oil film and is completely separated from the machine bed. Integrated oil chambers keep the process stable, irrespective of thermal fluctuations. As a result MÄGERLE grinding machines can withstand high loads without signs of wear – even in long-term use. The oil film has a vibration-damping effect and guarantees high-precision machining of simple or complex workpieces.

Powerful Grinding Wheel Drives

Power curves (S1)

Grinding wheel spindle drives

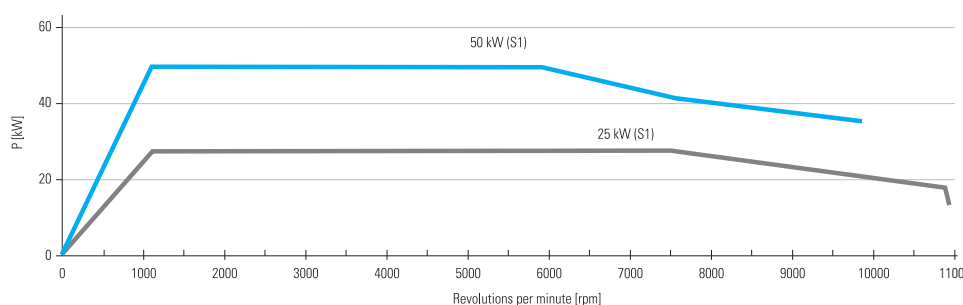

Precise and reliable down to the smallest detail

MÄGERLE guarantees precision and reliability down to the smallest detail of its grinding machines. Water-cooled direct drive motors for the grinding spindles ensure maximum performance in demanding continuous operation. The HSK

tool mounting is the key to quick tooling change with absolute repeatability precision. An optional balancing system dynamically balances unequal forces in the rotating grinding wheel.

Front-runner in grinding power

Powerful motors drive the spindles on MÄGERLE grinding machines and lead to outstanding results in respect of removal capacity. MÄGERLE surface and profile grinding machines combine top quality with maximum productivity.

MFP 100 working area configuration

- ❶ Wheel carriage with 2 quick-change spindles
- ❷ Diamond dressing roll
- ❸ Machining tool
- ❹ Workpiece
- ❺ Fixture
- ❻ NC indexing head 2/3 axes

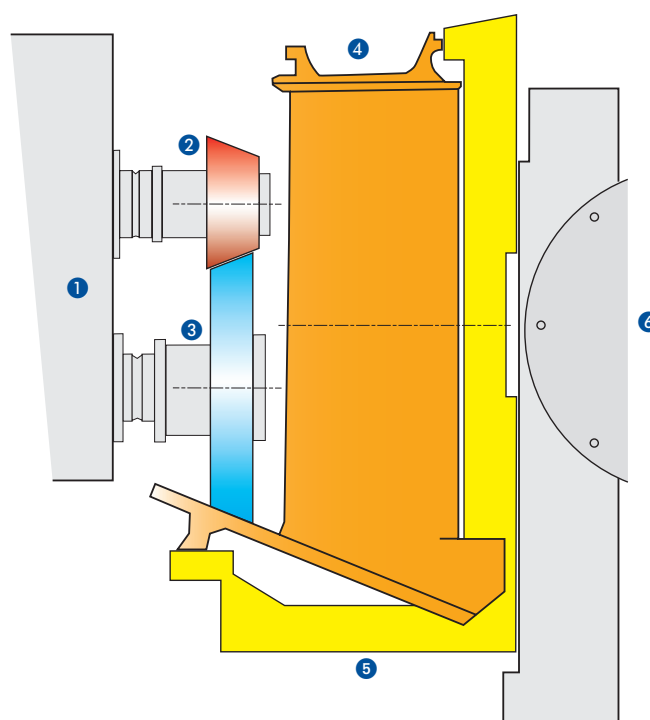

Tool Changer System for Demanding Applications

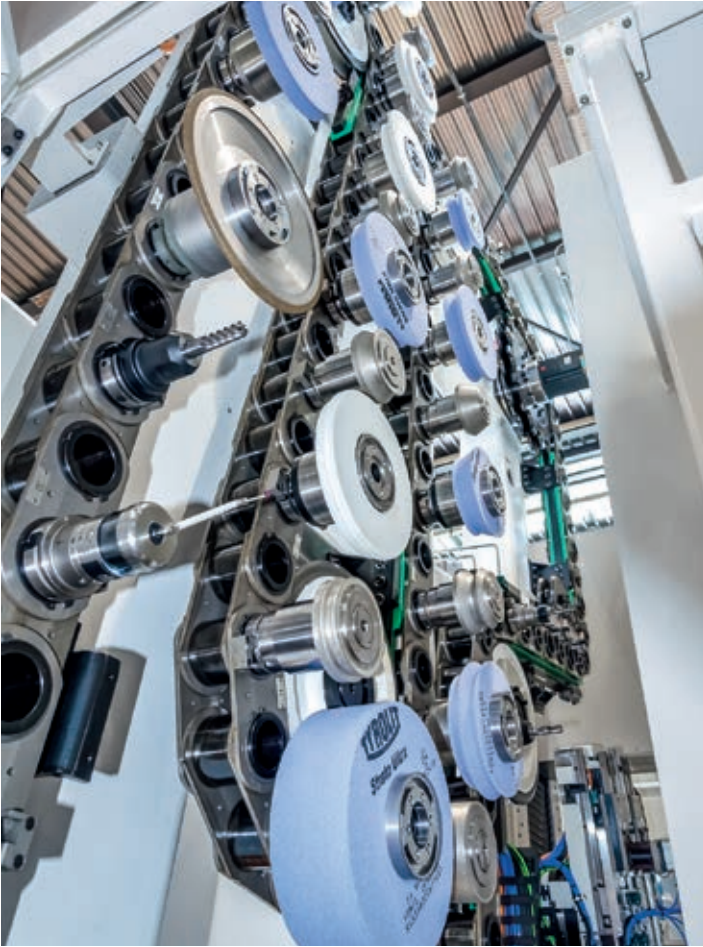

Short tool change cycles

The superior tool and dressing roll changer system is an outstanding feature of the MFP 100. The dual gripper changes grinding wheels and associated diamond dressing rolls simultaneously - thus resulting in a noticeable reduction in idle time. The accelerated tool change cycles are accompanied by markedly increased axis dynamics. The overall increase in productivity achieved with the new MFP 100 grinding center results in a significant reduction in unit costs.

Up to 60 tool stations

The MFP 100 tool changer is scalable. The standard version of the tool changer can be equipped with up to 30 tool holders. It can optionally be increased to up to 60 tool stations. The MFP 100 tool management system is also generously designed and can manage up to 500 different tools. In addition to max. 300 mm diameter grinding wheels and corresponding max. 160 mm diameter diamond dressing rolls, it is possible to load the tool changer with tools such as drills, milling cutters, CBN wheels or measuring probes.

The Right Dressing Method



The dressing of the grinding wheels is a crucial factor for the efficiency of the grinding process. With overhead and table dressing devices, MÄGERLE provides professional solutions for the various requirements of this process step. The potential of the overhead principle is developed in continuous dressing (CD) and inprocess dressing (IPD). Table dressing devices are

used for fixed or rotating dressing tools, where the rotating principle produces optimal results in diamond full form dressing, crushing or CNC dressing. MÄGERLE uses servo motors for driving the dressing devices; these can be freely programmed across the entire rpm range.

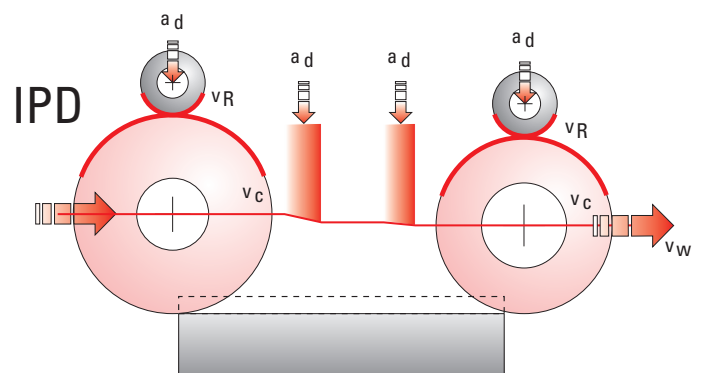
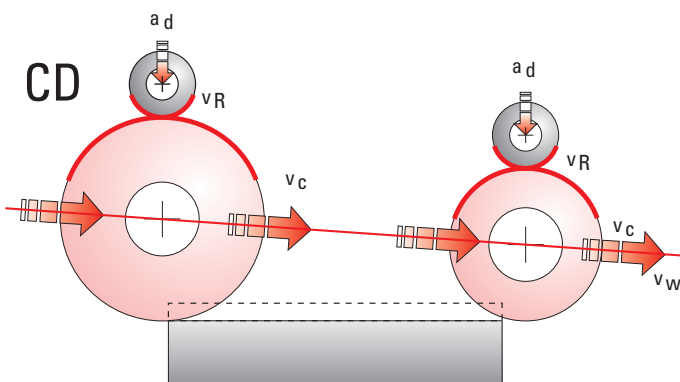

Cooling Intelligence

Perfect protection of the machining area, long working life of the entire system



Cost-saving cooling intelligence

The NC systems currently used in MÄGERLE Grinding Centers allow precise positioning of the coolant supply together with the respective grinding wheel geometry over 2 NC axes. An optional profile adjustment enables precise application of the coolant to the workpiece zones for machining.

Minimal coolant amounts thus provide maximum cooling capacity. Labyrinth seals with a sealing air arrangement protect all bearings in the machining area from impurities and contribute to the long working life of the overall system.

MFP 100 Nozzle changer configuration

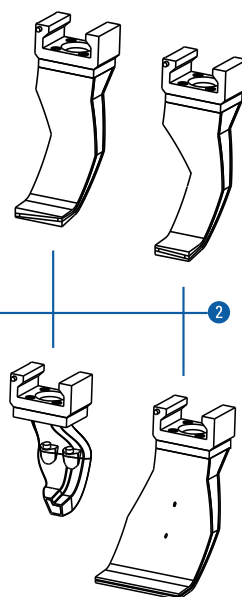
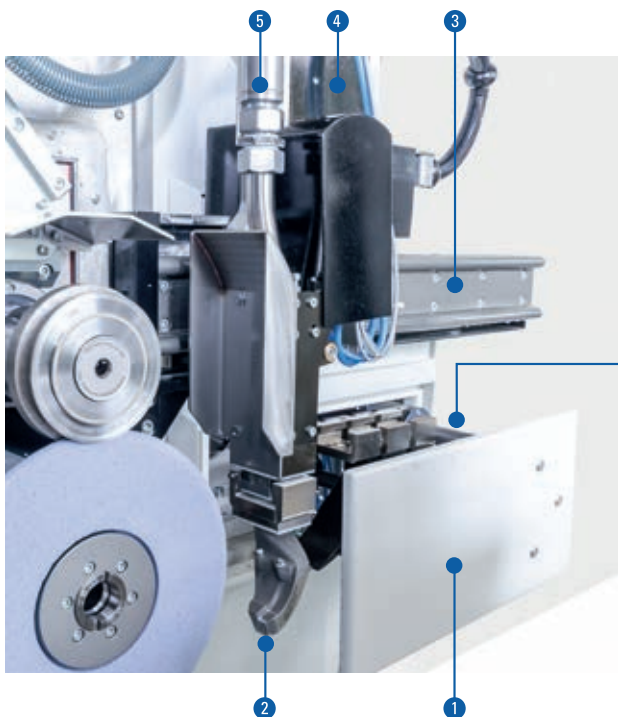

- 1 Nozzle changer magazine
- 2 Coolant nozzle
- 3 Horizontal delivery nozzle
- 4 Vertical delivery nozzle
- 5 Coolant supply

Coolant Cleaning Units

The optimal solution for every application

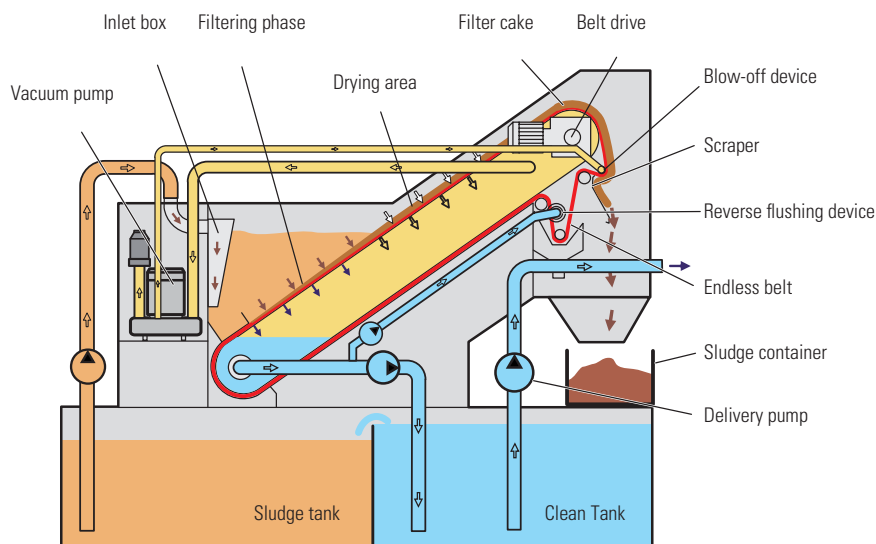

Endless belt with brush-of device

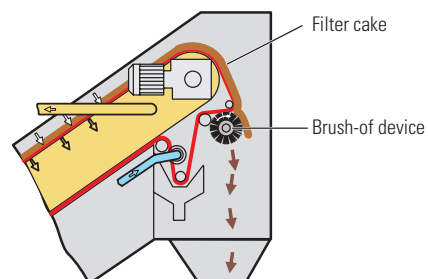

Filter fleece with take-up unit

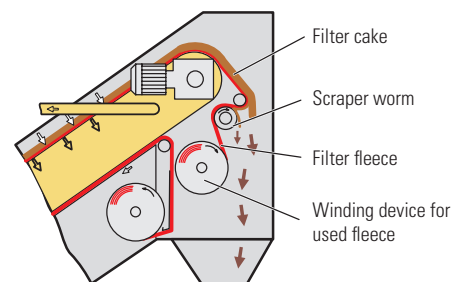

An eye on the big picture

MÄGERLE considers the grinding process as a system of different components and thus creates the necessary conditions for a high cost effectiveness. The system concept for coolant supply and cleaning is of central importance. Correct dimensioning is essential for utilization of the full

coolant potential with low disposal costs. Taking account of these economic and ecological aspects, MÄGERLE in conjunction with the coolant system supplier matches integrated solutions to the customer-specific requirements.



Control Systems

Operational safety and user-friendliness in the center

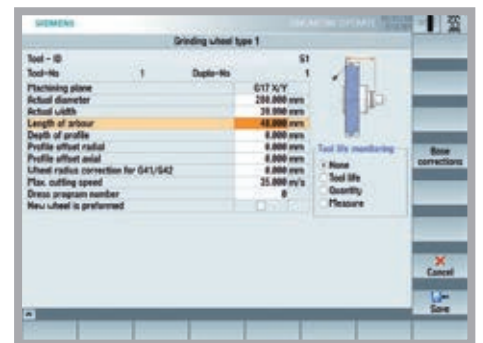
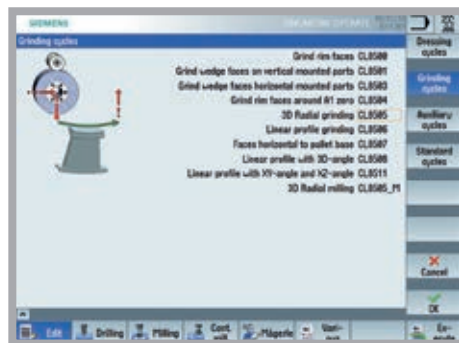
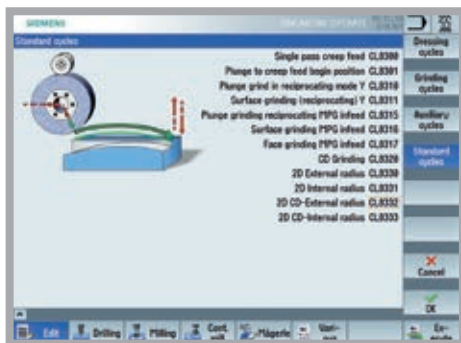

At MÄGERLE, experienced software engineers work on advanced control concepts. The focus is on intuitive operation and the highest level of operational and production safety. The freely programmable software allows the control unit to be configured workpiece-specifically and in

accordance with customer requirements. A mobile manual control unit with visualization of all relevant functions on the LCD monitor simplifies and accelerates precise setup of the machine directly at the workpiece. The SIEMENS Sinumerik 840D solution line control unit assures

the highly automated operation of MÄGERLE grinding centers with precise control of the individual axes. Innovative control architecture and MÄGERLE's groundbreaking machine tools thus form a perfectly functioning unit geared to customer requirements.

Customer Care

MÄGERLE surface and profile grinding machines should fulfill the customer's requirements for as long as possible, work cost-effectively, function reliably and be available at all times. From "start up" through to "retrofit" – our Customer Care is there for you throughout the working life of your machine. 3 professional helplines and trained service technicians are available in your area, wherever you are in the world.

- We will provide you with fast, uncomplicated support.
- We will help to increase your productivity.
- We work professionally, reliably and transparently.
- We will provide a professional solution to your problems.



Start up

Commissioning
Warranty extension



Qualification

Training
Production support



Prevention

Maintenance
Inspection



Service

Customer service
Customer consultation
HelpLine
Remote service

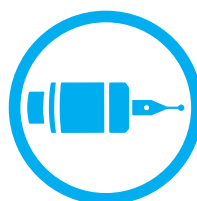

Material

Spare parts
Replacement parts
Accessories



Rebuilt

Machine overhaul
Assembly overhaul



Retrofit

Modifications
Retrofits

Machine Layout

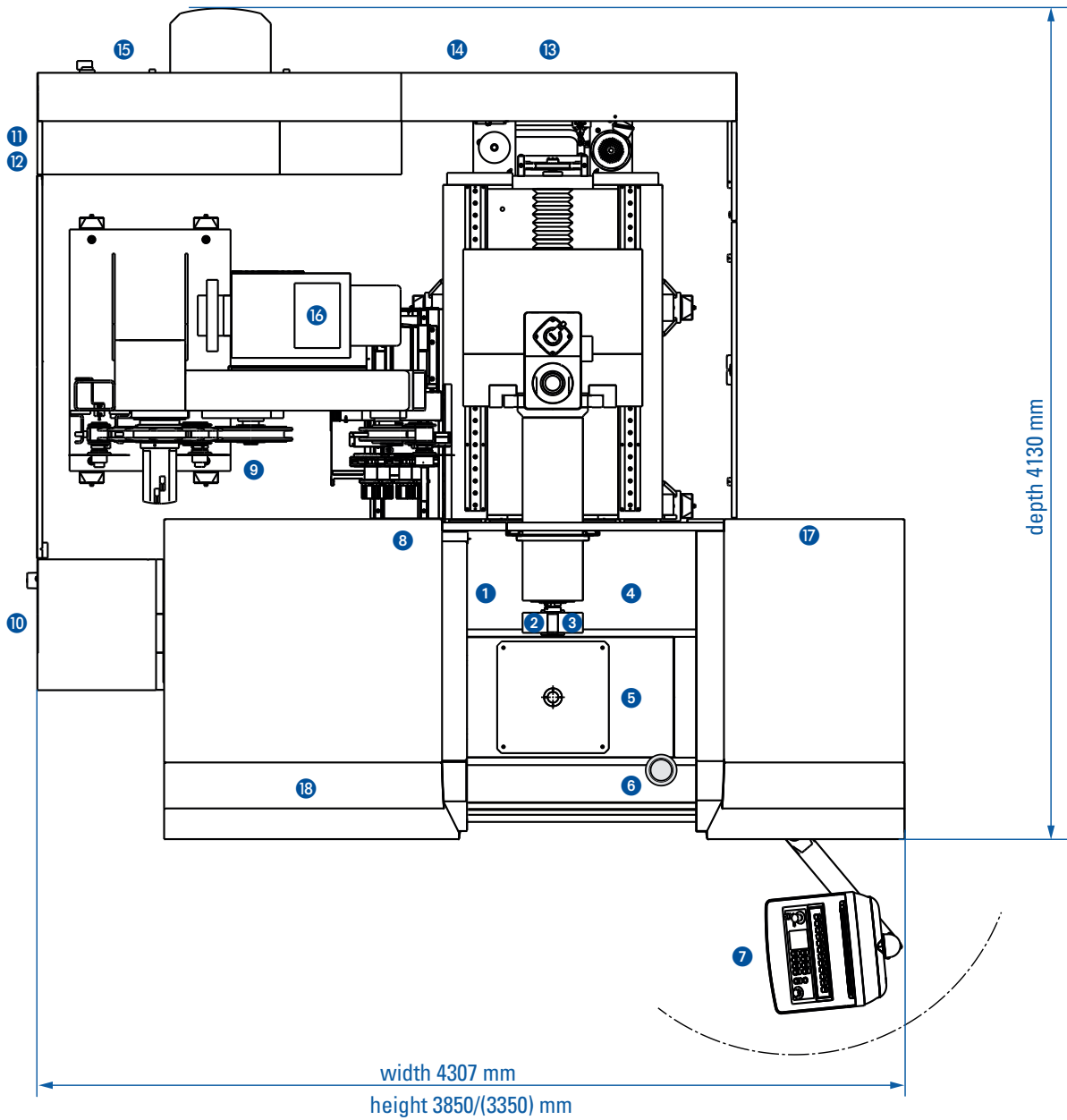

MFP 100 machine configuration

- | | |
|---------------------------------------------------|--------------------------------------------------|
| ① MFP 100 working area | ⑩ Input station for tool management |
| ② Quick-change spindle for machining tools | ⑪ Interface to coolant processing system |
| ③ Quick-change spindle for diamond dressing rolls | ⑫ Interface to cooling system for spindle drives |
| ④ Automatic coolant nozzles | ⑬ Hydrostatic/Hydraulic unit |
| ⑤ NC indexing head 2/3 axes | ⑭ Centralized lubricating system |
| ⑥ Dressing device | ⑮ Electrical cabinet |
| ⑦ Sinumerik 840D controller | ⑯ Mist extractor (interface) |
| ⑧ Dual gripper | ⑰ Automatic door drive |
| ⑨ Tool change magazine | ⑱ Safety splash guard cabin |

Technical data

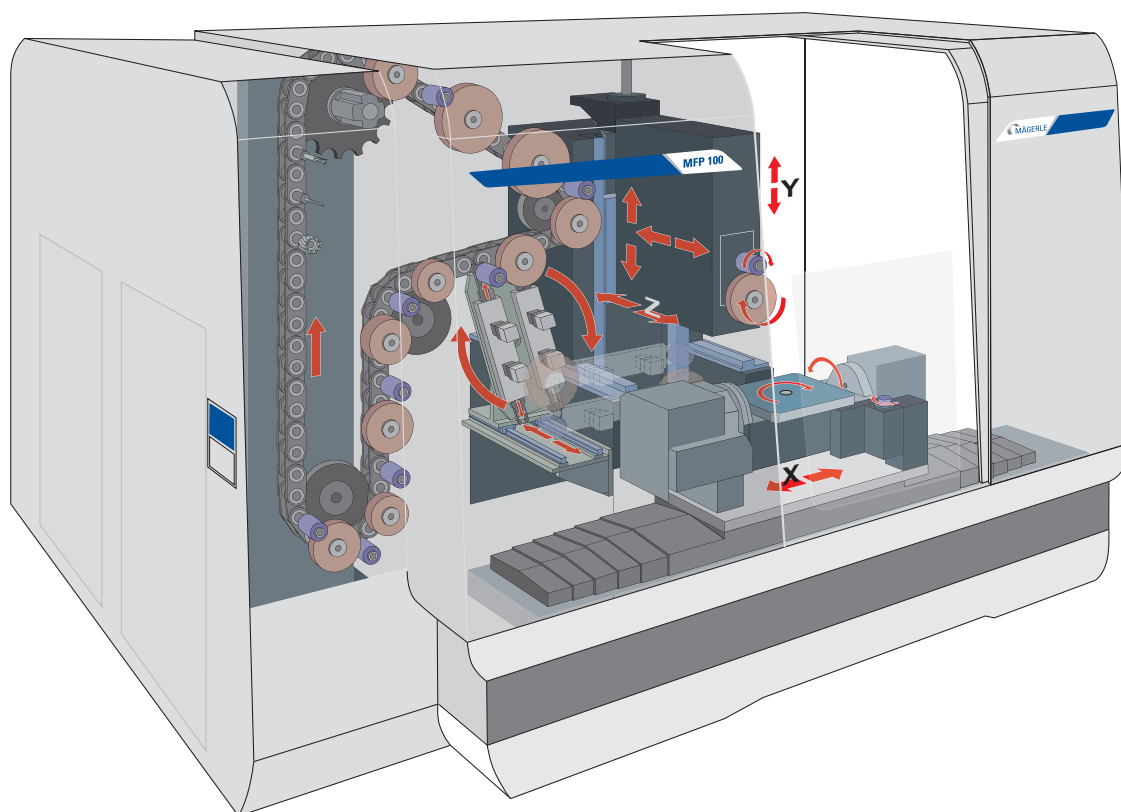

Technical data MFP 100

X-axis	longitudinal stroke	mm	1000
	Travel speed	mm/min	0...40,000
Y-axis	vertical stroke	mm	950
	Travel speed	mm/min	0...30,000
Z-axis	transverse stroke	mm	750
	Travel speed	mm/min	0...30,000
Grinding spindle drive - power max.		kW	50
Rpm range max.		rpm	0...10,000
VV-axis profile crushing device, roll width, max.		mm	100
Tool changer positions - grinding wheels		n/pos	30/60
Nozzle changer positions (optional)		n/Pos	8
Tool length max.		mm	280
Grinding wheel dimensions (D x T x H)		mm	300 x 100 x 76.2
Tool adapter			HSK-B80
Indexer swivel axes		n/axes	2/3
Integrated swivel single side dresser roll (optional)			
Measuring system with feeler			

We reserve the right to make technical changes



Mägerle AG Maschinenfabrik
Allmendstrasse 50
CH-8320 Fehraltorf
Phone +41 43 355 66 00
Fax +41 43 355 65 00
sales@maegerle.com
www.maegerle.com

