

S121

The reasonably priced machine
for diverse internal grinding applications.



Key data

The S121 is a universal internal cylindrical grinding machine for medium-sized workpieces in individual and small batch production. It has a swing diameter of 400 mm.

GLOBAL
TECHNOLOGY LEADER
PERFECTION
CUSTOMER FOCUS
EFFICIENCY
SAFETY
SOPHISTICATED PROCESSES
PRECISION

The Art of Grinding.

TECHNOLOGY LEADER
EFFICIENCY
PERFECTION
CUSTOMER FOCUS
PRECISION
GLOBAL
SOPHISTICATED PROCESSES
SAFETY

Fritz Studer AG

The name STUDER stands for more than 100 years of experience in the development and production of precision cylindrical grinding machines. «The Art of Grinding.» is our passion, highest precision is our aim and top Swiss quality is our benchmark.

Our product line includes both standard machines, as well as complex system solutions in high-precision cylindrical grinding for machining small and medium-sized workpieces. In addition we offer software, system integration and a wide range of services. As well as receiving a complete tailor-made solution the customer also benefits from our 100 years of know-how in relation to the grinding process.

Our customers include companies from the machine tool industry, automotive engineering, tool and die makers, the aerospace industry, pneumatics/hydraulics, electronics/electrical engineering, medical technology, the watch industry and job order production. They value maximum precision, safety, productivity and longevity. 24 000 manufactured and delivered systems make us the market leader and are clear evidence of our technological leadership in universal, external, internal and noncircular grinding. Around 800 employees, including 75 apprentices, make it their goal every day to ensure that «The Art of Grinding.» will continue to be closely linked to the name STUDER in the future.

S121

If you don't want to miss out on the latest technology in internal grinding, then take a moment – for the S121. This reasonably priced universal machine can handle a wide range of internal grinding applications. The incomparable STUDER precision is based on the Granitan[®] machine bed and the StuderGuide[®] guide-way system. During the development of the machine the highest attention was given to the ergonomics, be it in connection with grinding, the machine set-up or with the maintenance of the machine.

Features

Dimension

- Swing diameter above the table 400 mm
- Max. workpiece length (including clamping device) 300 mm
- Internal grinding length 175 mm
- Maximum workpiece weight 125 kg

Hardware

- StuderGuide® guide system with linear drive
- Spindle turret with two grinding spindles or one fixed spindle
- C-axis for the workhead enabling form and thread grinding
- Full enclosure with two sliding doors
- Granitan® S103 mineral casting machine base



Software

- Very simple operation and programming thanks to StuderWIN
- Short setup and resetting times e.g. with Studer Quick-Set
- Standardized interfaces for loader and peripheral devices



The S121 universal internal cylindrical grinding machine has an exceptional price/performance ratio and is the ideal machine for internal, surface and external grinding of chuck components. It has a host of sophisticated technical features such as the revolutionary StuderGuide® guideway system, high-precision axis drives with linear motors, a swivel-in dressing unit, etc. The S121 is the ideal machine for a wide range of internal grinding applications. Many workpieces are in the areas of machine tools, drive elements, aerospace, die and mold.

Precision is the result of perfect interaction between a large number of different factors. The basis is the Granitan® S103 machine bed with its excellent cushioning and thermal behavior. The modules are ideally suited to each other and produced with the customary STUDER precision. The large distance between the guideways and the very rigidly constructed slides form the basis for the precision and productivity of this machine. All components involved in defining precision are temperature-stabilized.

StuderWIN creates a stable programming environment and contributes to efficient use of the machine. A PC is integrated into the CNC control system. The possibility of fully integrating the in-process gauging and sensor technology for process monitoring as well as contact detection and balancing systems in the control enable standardized programming of the different systems. The drive elements are optimally adapted to the control.



Granitan® S103 mineral casting machine base

1



- Vibration damping
- Thermally stable
- Non-wearing

The material structure developed by STUDER and which has proved its superb efficiency over many years is produced in the company's own plant using the most modern industrial techniques. The excellent cushioning behavior of the machine base ensures outstanding surface quality of the ground workpieces. The service life of the grinding wheel is also increased, leading to reduced downtimes. Temporary temperature fluctuations are extensively compensated by the favorable thermal behavior of Granitan®. This provides high stability throughout the day. The Studer-Guide® guide system for the longitudinal slide is formed directly in the machine bed and coated with Granitan® S200 wear-resistant guideway surfacing material. The guideways offer the highest possible accuracy through the entire speed range with high load capacity and cushioning levels. Thanks to the robust and maintenance-free design, these excellent guideway characteristics are more or less completely retained.

2

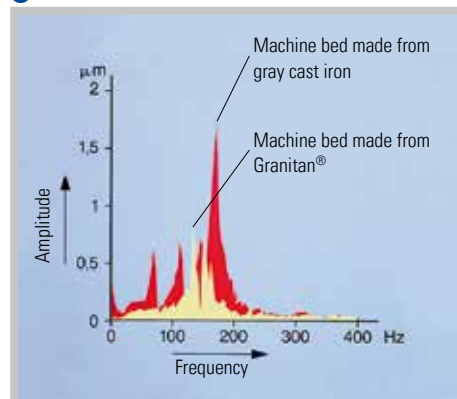

1 Machine bed with longitudinal guides

2 Vibration behavior of gray cast iron and Granitan® S103

StuderGuide® in the longitudinal and transverse axis

1



2



- High geometrical traversing accuracy
- Effective covering of the guideways

The StuderGuide® guide system for the X and Z axis is coated with Granitan® S200 wear-resistant guideway surfacing material and offers the highest possible accuracy through the entire speed range with high load capacity and cushioning levels. StuderGuide® extends the benefits of hydrostatic systems and guideways with a patented surface structure. A big advantage of StuderGuide® in comparison with hydrostatic guides is the cushioning component in the direc-

tion of motion. The slides are powered by linear motors with direct measuring systems with a resolution of 10 nanometers. The maximum travel speed is 20 m/min for both axes. This provides the basis for high-precision and efficient grinding with the shortest possible auxiliary times. The combination of StuderGuide®, linear motors and direct measuring systems guarantee the highest possible interpolation accuracies.

Grinding spindle

1



2



3



- 1 fixed spindle or 2 spindles on turret
- Large selection of grinding spindles

The S121 can be configured with a fixed spindle or a spindle turret with two spindles. The spindle turret swivels hydraulically through 180° to a stop. One spindle can be equipped with an external grinding wheel.

Workhead



- Movable workhead
- Cylindricity correction
- Good ergonomics

The workhead is adjustably mounted on the workpiece table. The driving power is 1.6 kW, and the load for live spindle grinding is maximum 300 Nm. It also features manual cylindricity correction. The high-resolution C-axis with direct measuring sys-

tem is ideally suited for form and thread grinding. The machine concept allows optimal accessibility for the operator, whether for workpiece changeover, dressing or grinding wheel change.

Dressing

1



2



3

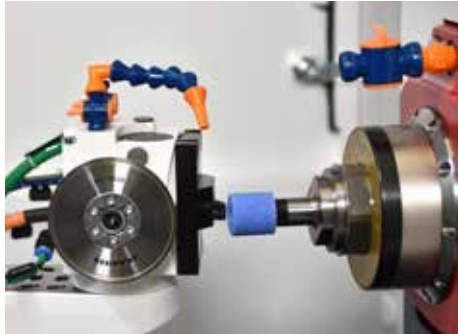

- Configurable according to clients requirements
- Rotating or stationary dressing tools can be used

An easy-cutting grinding wheel is essential for cost-effective and high-quality grinding. Rotating and fixed dressing tools can be mounted on the pivoting dressing unit. This makes it possible to coordinate the dressing process flexibly and optimally with the characteristics specific to the workpiece, tool or materials. The grinding wheel profile and dressing parameters are easily de-

finied via macros. Another STUDER speciality is the grinding wheel reference points (T-numbers). This enables programming with normal dimensions, which considerably facilitates the development of grinding programs. A software package is available to fine tune the dressing process and includes additional dressing functions.

Control system and operation

1



- PCU manual control unit
- EMC-tested control cabinet
- Ergonomically designed Operating elements

The S121 is equipped with a 31i-B series Fanuc control unit with integrated PC. The 15" touch screen facilitates intuitive operation and programming of the machine. All controls are clearly and ergonomically arranged. An important role is played by the manual control unit, which facilitates setup close to the grinding process. A special function – the Sensitron electronic contact detection device – reduces downtimes to a minimum.

2



StuderWIN

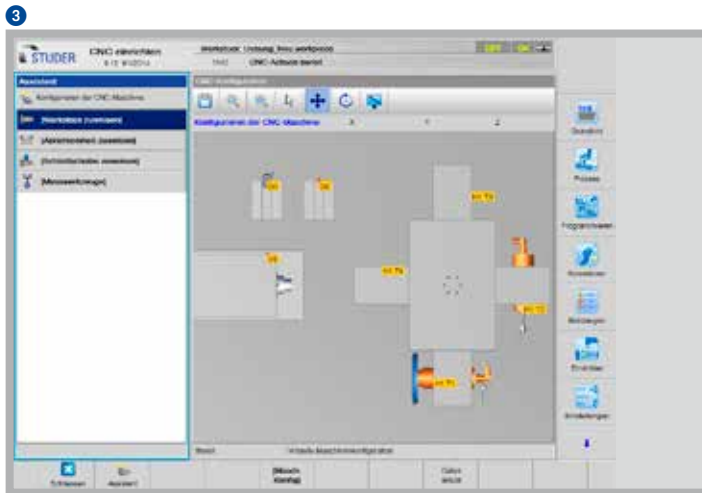
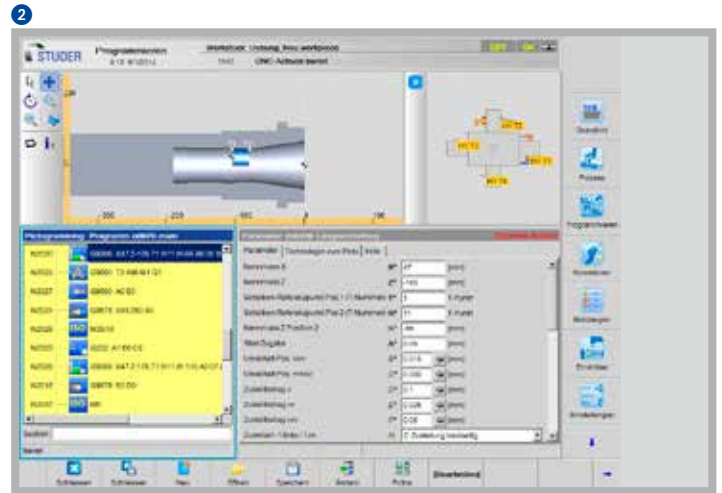
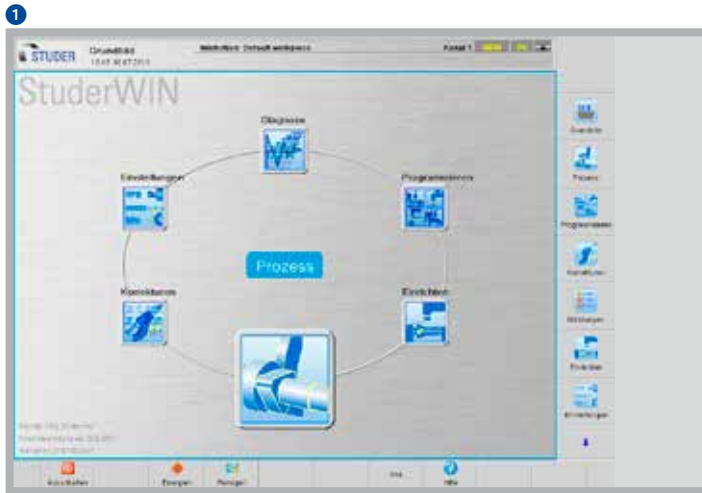

- Latest software technology
- StuderPictogramming

The StuderWIN operator interface creates a stable programming environment and contributes to efficient use of the machine.

The possibility of fully integrating the in-process gauging and sensor technology for process control as well as contact detection and automatic balancing systems in the operator interface enables standardized programming of the different systems. The drive elements are optimally adapted to the control.

The sophisticated mechanical engineering concept of the S141 is completed by a grinding software program developed in-house by STUDER and which is continuously further optimized in collaboration with users of the software. This software offers:

- StuderPictogramming: The operator strings the individual grinding cycles together – the control unit generates the ISO code.
- STUDER Quick-Set: The software for grinding wheel alignment reduces resetting times by up to 90%.
- Microfunctions: Free programming of grinding and dressing process sequences for optimization of the grinding process.
- Integrated operating instructions assist safe machine operation.
- The software options for grinding technology calculation, optimized dressing as well as contour, thread and form grinding additionally increase the machine's functionality.

Customer Care

STUDER cylindrical grinding machines should fulfill the customers requirements for as long as possible, work cost-effectively, function reliably and be available at all times. From «start up» through to «retrofit» – our Customer Care is there for you throughout the working life of your machine. 30 professional helplines and more than 60 service technicians are available in your area, wherever you are in the world.

- We will provide you with fast, uncomplicated support.
- We will help to increase your productivity.
- We work professionally, reliably and transparently.
- We will provide a professional solution to your problems.

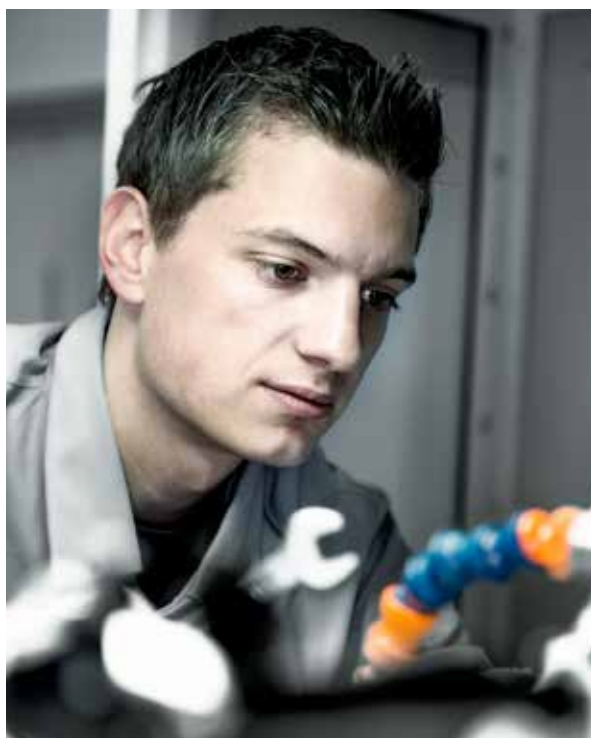

Start up

Commissioning
Warranty extension



Qualification

Training
Production support



Prevention

Maintenance
Inspection



Service

Customer service
Customer consultation
HelpLine
Remote service

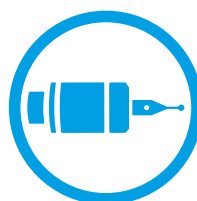

Material

Spare parts
Replacement parts
Accessories



Rebuild

Machine overhaul
Assembly overhaul



Retrofit

Modifications
Retrofits

Technical data

Main dimensions

Swing diameter above table	400 mm (15.7")
Workpiece diameter	max. 360 mm (14.2")
Workpiece length incl. clamping device	max. 300 mm (11.8")
Internal grinding length	max. 175 mm (6.9")
External grinding length	max. 100 mm (3.9")

Transverse axis X

Max. travel	350 mm (13.8")
Speed	0.001–20 000 mm/min (0.000,04–787 ipm)
Resolution	0.00001 mm (0.000,000,4")

Longitudinal axis Z

Max. travel	350 mm (13.8")
Speed	0.001–20 000 mm/min (0.000,04–787 ipm)
Resolution	0.00001 mm (0.000,000,4")

Grinding spindle turret

Linear spindles up to max.	1
Spindles on turret up to max.	2
Turret swiveling positions	0 deg / 180 deg
Turret repetition accuracy	< 1"
Turret swiveling time	< 4 s

Internal grinding

Locating bore dia.	100/120/140 mm (3.9" / 4.7" / 5.5")
Speeds	6 000 – 120 000 rpm
Grinding mandrel length (swiveling on the turret)	max. 200 mm (7.9")

External grinding

Peripheral speed	50 m/s (9840 sfpm)
Fitting taper	1 : 10 / 40 mm
Grinding wheel	dia. 300 / 127 x 32 mm (11.8" x 5" x 1.3")

Options

Length positioning active
Manual balancing

Workhead

Rpm range	1 – 1 500 rpm
Holding fixture	A4 according to DIN/ISO 702-1 / MK5
Bar capacity	35.5 mm (1.4")
Drive power	3 kW (4 hp)
Load for live spindle grinding	300 Nm (224 ft lbs)

C-axis for form grinding

– High-precision, direct measuring system	0.0001 deg
---	------------

Control unit

Fanuc 31i -B with integrated PC
15" touch screen

Connected loads

Total connected load	32 kVA
Air pressure	5.5 bar (80 psi)
Extraction capacity for cooling lubricant mist	1 200 – 1 800 m ³ /h

Installation dimensions

Machine dimension L x W (without operating panel)	2 110 x 1 625 mm (83" x 64")
Total weight	4 400 kg (9680 lbs)

Installation plans

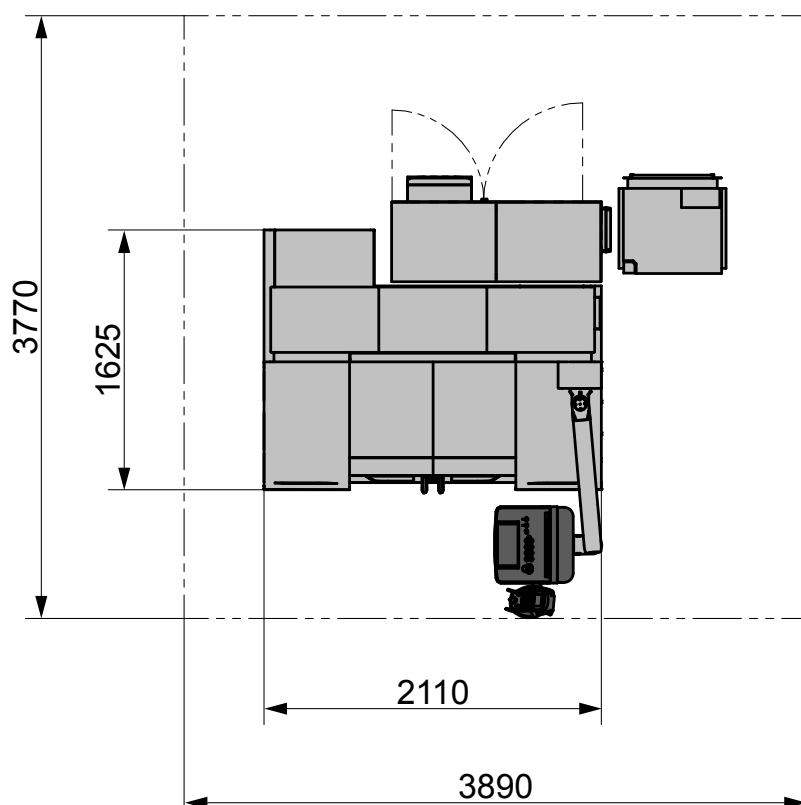
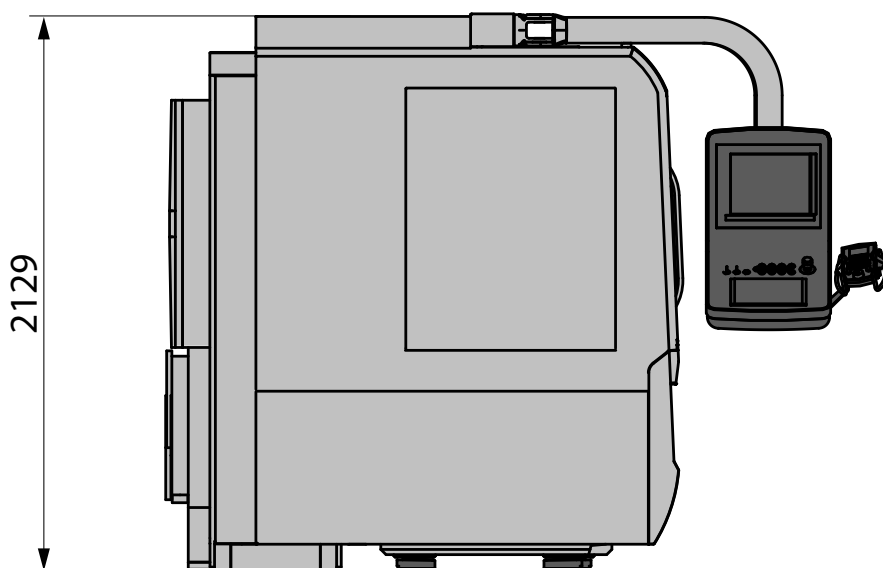

The information given is based on the technical levels of our machine at the time of this brochure going to print. We reserve the right to further develop our machines technically and make design modifications. This means that the dimensions, weights, colours, etc. of the machines supplied can differ. The diverse application possibilities of our machines depend on the technical equipment

specifically requested by our customers. The equipment specifically agreed with the customer is therefore exclusively definitive for the equipping of the machines, and not any general data, information or illustrations.



Fritz Studer AG
3602 Thun
Switzerland
Phone +41 33 439 11 11
Fax +41 33 439 11 12
info@studer.com
www.studer.com



ISO 9001
VDA6.4
certified

